

FUME-A-VENT™ EXHAUST REMOVAL SYSTEMS!

A product of Air Cleaning Specialists, Inc.

Maintain A Healthy
Work Environment At
A Fraction Of The Cost!

AS EASY AS 1 - 2 - 3

**MOST COST EFFECTIVE
SYSTEM AVAILABLE**

**EASY INSTALLATION
BY US OR YOU**

**MEETS OR EXCEEDS
CODES**

1	2	3
		
Install our Quick-Fit clamp-together ducting and fan.	Install our state-of-the-art Control Panel	Drop our heat-resistant hose and source-capture nozzle from the ducting to the vehicle exhaust



100% SOURCE CAPTURE!

NORDFAB®
QUICK-FIT™

**The World's
Fastest Ducting!**



Made In The USA

**EASY CONNECT
NOZZLE HAS A
POSITIVE SEAL
WITH A SOFT BOOT**

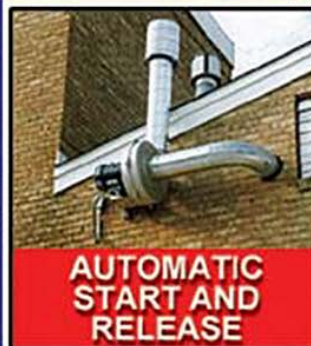

**AUTOMATIC
START AND
RELEASE**



AIR CLEANING SPECIALISTS, Inc.
11088 Gravois Ind Ct. St. Louis, MO 63128
636-349-4400 Fax: 636-349-0556
Toll Free: 866-455-2132

fumeavent.com

Plan View

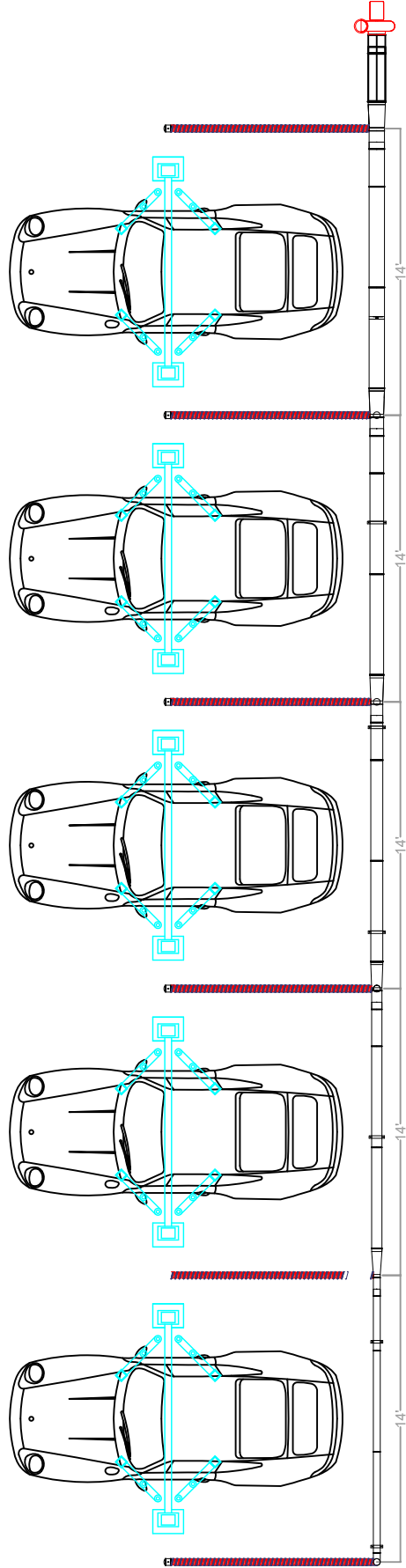

AIR CLEANING SPECIALISTS, INC.

Fume-A-Vent 4 Drop 4" Simple Drop System
with Quick-Fit Clamp-together Duct System
Ref Nordfab Quote No 10-1126 4' x 6 Drops

THIS PRINT IS THE PROPERTY OF
AIR CLEANING SPECIALISTS, INC.
826 HOKAN DRIVE
WYOMING, WY 83026
636 349-4400
AND IS ON LOAN TO THE RECIPIENT
SUBJECT TO RETURN UPON DEMAND.
IT'S CONTENTS ARE CONFIDENTIAL
AND MUST NOT BE COPIED OR SUB-
MITTED TO OUTSIDE PARTIES FOR
USE OR EXAMINATION.

THIS IS A CONCEPT DRAWING.
ALL EQUIPMENT LOCATIONS ARE
APPROXIMATE & SUBJECT TO CHANGE.

Side View

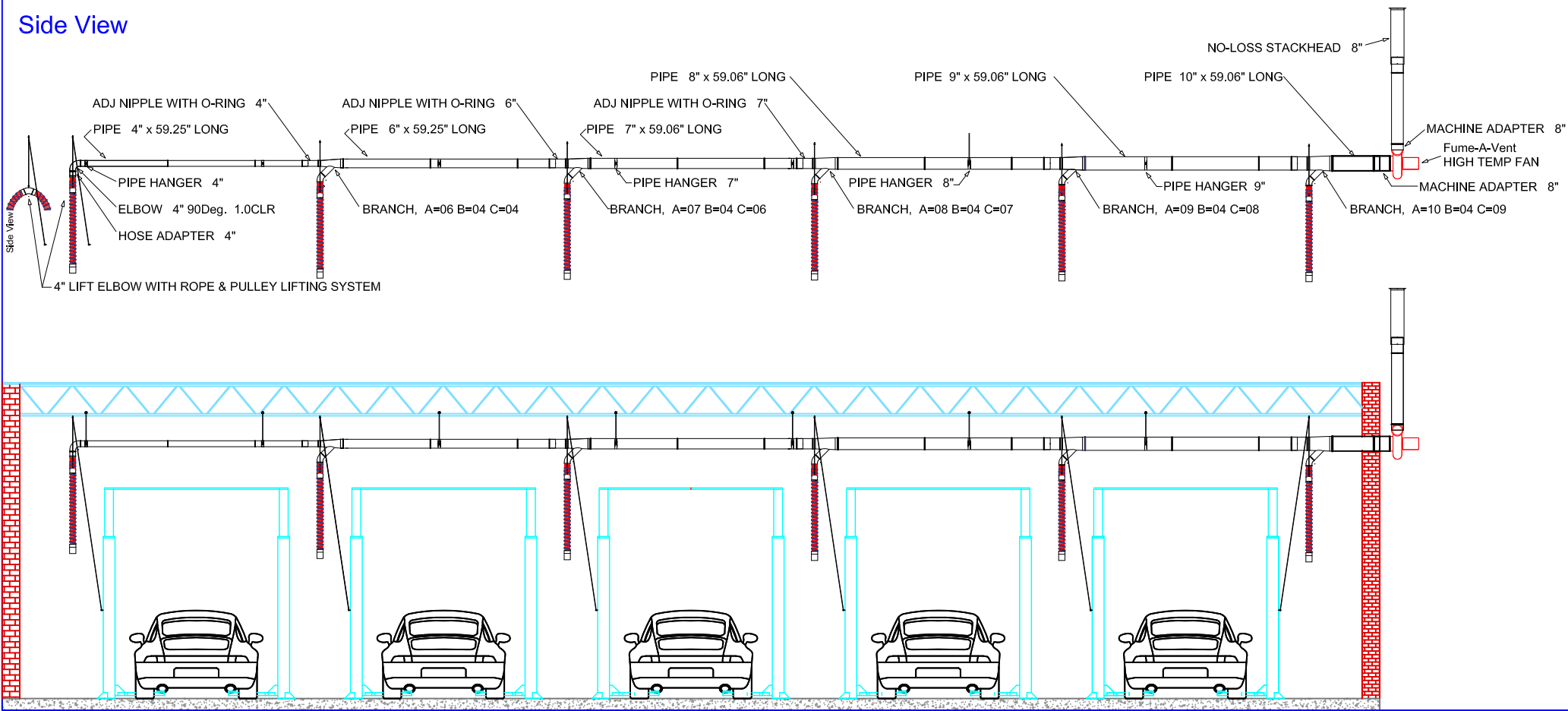



QUICK-FIT



THE WORLD'S FASTEST DUCTING

Q-F puts the squeeze on costly conventional duct installation.

Q-F is a snap! No complicated cutting, no riveting, no braising or welding are required. One Q-F clamp connects sections together in seconds. Branches, diverters, elbows - all adapt easily to your existing duct and may be taken apart and re-used or cleaned without special tools.

Q-F is easy to install, easy to align, and it's strong!

Q-F clamps are so easy to install, they almost install themselves. Simply place the clamp over the Q-F rolled lip ends and snap! The extraordinary strength of Q-F's specially machined double rolled lips provides a solid, straight run. The patented Q-F clamp connects the rolled ends. Snap the Q-F clamp and you have the strongest, safest, most re-usable dust-extraction piping available today. No special instructions or skills are needed to assemble a Q-F system. Install new lines, clean out lines or make changes to existing duct runs anytime you need to with Q-F.

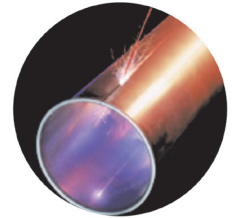

LASER WELDED SEAM

Q-F adapts to your every need; connect to the old or bring in the new.

Q-F has everything you need in galvanized or stainless steel parts:

- * **LASER WELDED** pipe in diameters from 3" to 24"
- * Branch fittings in all sizes and shapes
- * Elbows 30°, 45°, 60°, 90°
- * Larger custom sizes and special adapters
- * Blast Gates, Diverter Valves, Hoods, Manifolds.

Q-F adjusts to fit - without complicated measurements.

Planning to add, remove, or replace dust-extraction piping? Q-F's adjustable fittings slide together to create the precise length. No need for time wasted on exact measuring and precision cuts. Simply slide on and fit to your desired length, a few inches or a few feet. Need a different length for a new run? Just re-use your Q-F components and re-fit, again reducing your cutting and fabricating time.

Q-F saves you time and money.

Just how much money can you save using Q-F? Call us! You will be pleased with the savings and all the built-in advantages you get with Q-F.

Whether you need just a few parts, or help with a complete system, Q-F has 4 to 5 day lead time.

Call for a free sample.

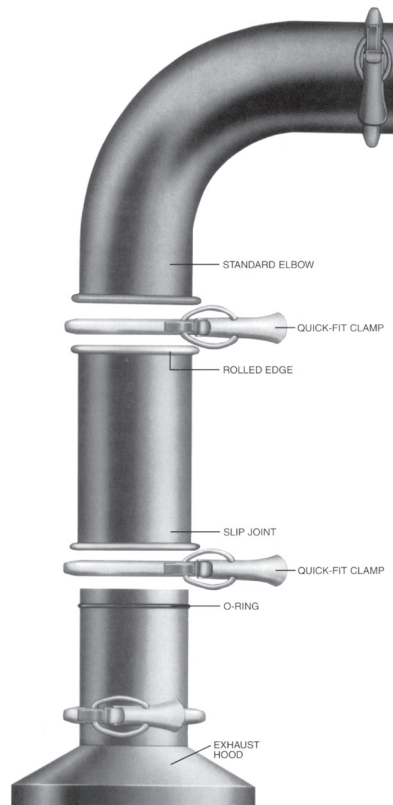

Air Cleaning Specialists Inc.
11088 Gravois Ind Ct.
St. Louis, MO 63128
Toll Free: 800-878-5030
Fax: 636-349-0556
www.ductingsystems.com



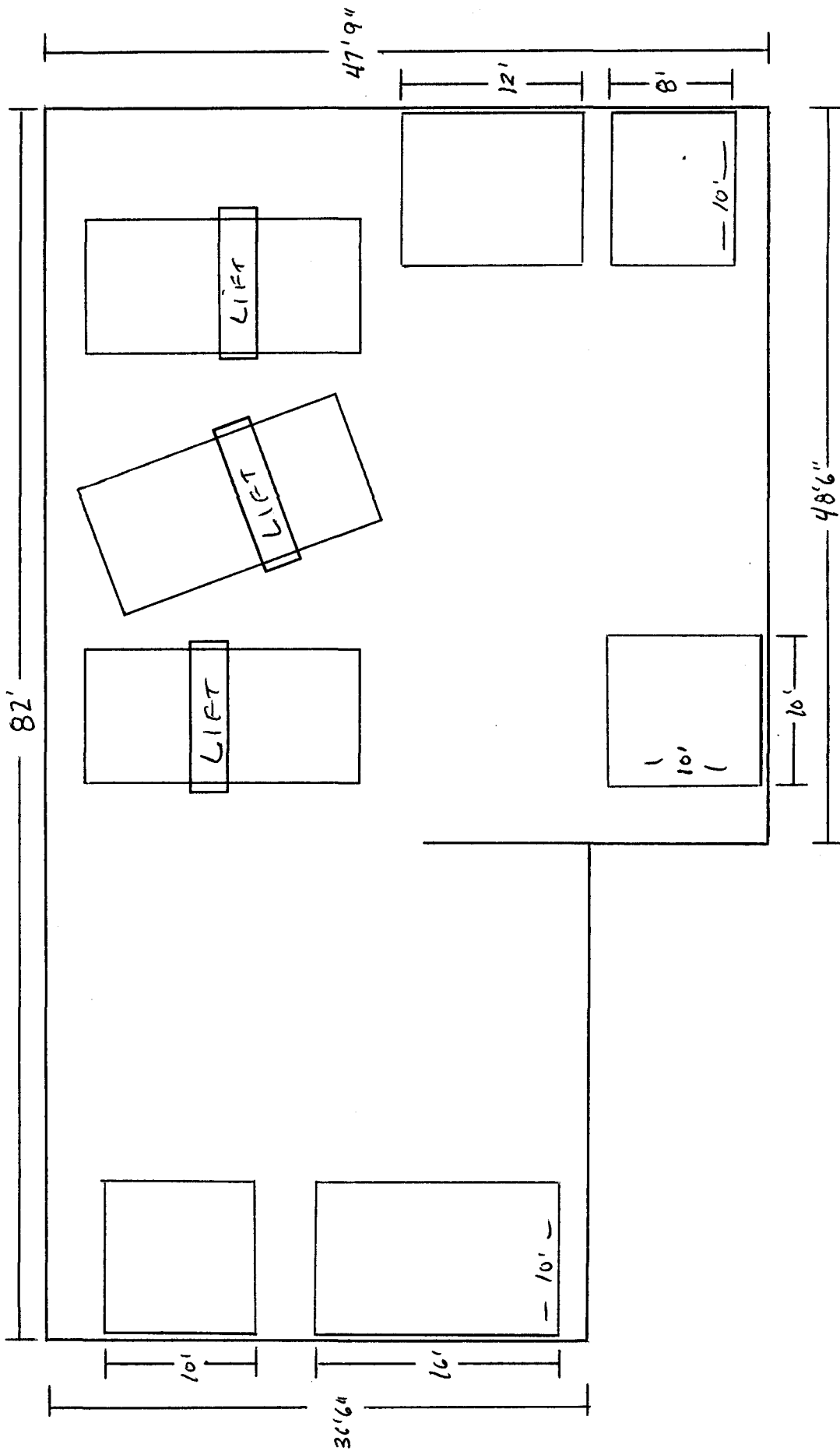

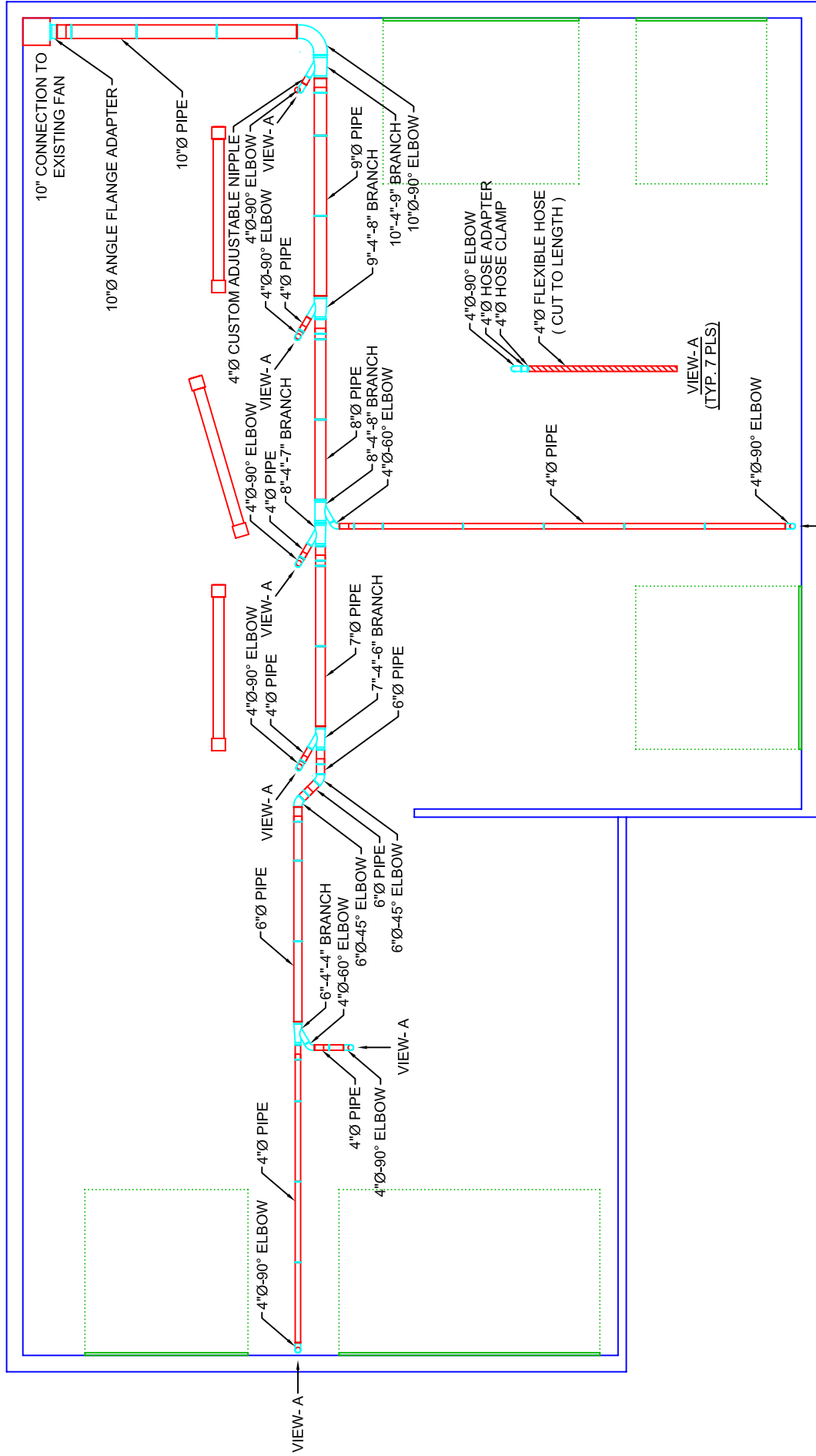

THE TECHNICAL AND MECHANICAL INFORMATION CONTAINED HEREON IS PROPRIETARY AND CONFIDENTIAL INFORMATION. COPYING, REPRODUCING OR DISCLOSING THIS INFORMATION AND/OR DRAWING WITHOUT THE PRIOR WRITTEN CONSENT OF IS PROHIBITED.

RETENTION AND/OR USE OF THIS INFORMATION ACKNOWLEDGES ACCEPTANCE OF ALL THE TERMS, CONDITIONS AND LIABILITIES THEREOF.

SIGNATURE _____ TITLE _____

REVISION	DATE	BY

Fume-A-Vent Vehicle Exhaust Extraction System

HOLLYWOOD MOTOR Co.

SCALE _____

DATE 08/01/2007

DRAWN BY RAL

CK'D

DRAWING NO. HOLLYWOOD