

Fume-A-Vent Spring Operated Hose Reel

Date 4/12

Part No. HRS-X-XXXX

Hose Reels

TAB 3-B-2



Shown above: **Fume-A-Vent** Model HRS-3-0420 Spring Hose Reel with 4" x 20' Series 3 400° Rubber Impregnated Polyester Hose. Plus the optional TPA0303-SC Tailpipe Adapter, Oval Mouth Neoprene for 3" & 4" Neoprene Hose with Spring Clamp

The Reels are offered in standard 4", 5", 6" and 8" inch hose diameters. The Reels are supplied completely assembled and ready for installation. The Reels may be connected with ductwork to a central exhaust system or each reel may be supplied with a direct mount Fan.

Fume-A-Vent Hose Reels may be mounted in three positions: from an overhead support structure, from a side support structure or on the floor. Ceiling mounts are most common, however wall mounts and floor mounts are options when space is at a premium.

FUME-A-VENT
EXHAUST REMOVAL SYSTEMS
A Product of Air Cleaning Specialists, Inc.

AIR CLEANING SPECIALISTS, INC.
11088 Gravois Industrial Ct. St. Louis MO 63128
866 455-2132 Fax 636 349-0556
www.fumeavent.com info@fumeavent.com

This drawing has been copyrighted
and is the property of
Air Cleaning Specialists, Inc.

Fume-A-Vent Hose Reel Mounting

Date 7/12

Part No. HRX-X-XXXX

Hose Reels

TAB 3-B-5

This is a drawing of the typical mounting positions that our Fume-A-Vent Hose Reels are placed. They are easily installed with the four mounting holes that are 9/16" by 3/4" deep. Unistrut can be utilized effectively with the mounting holes or by other methods. Please consult one of our experts to decide the best mounting type for your application. Both Spring and Motorized Hose Reels have the same mounting options and

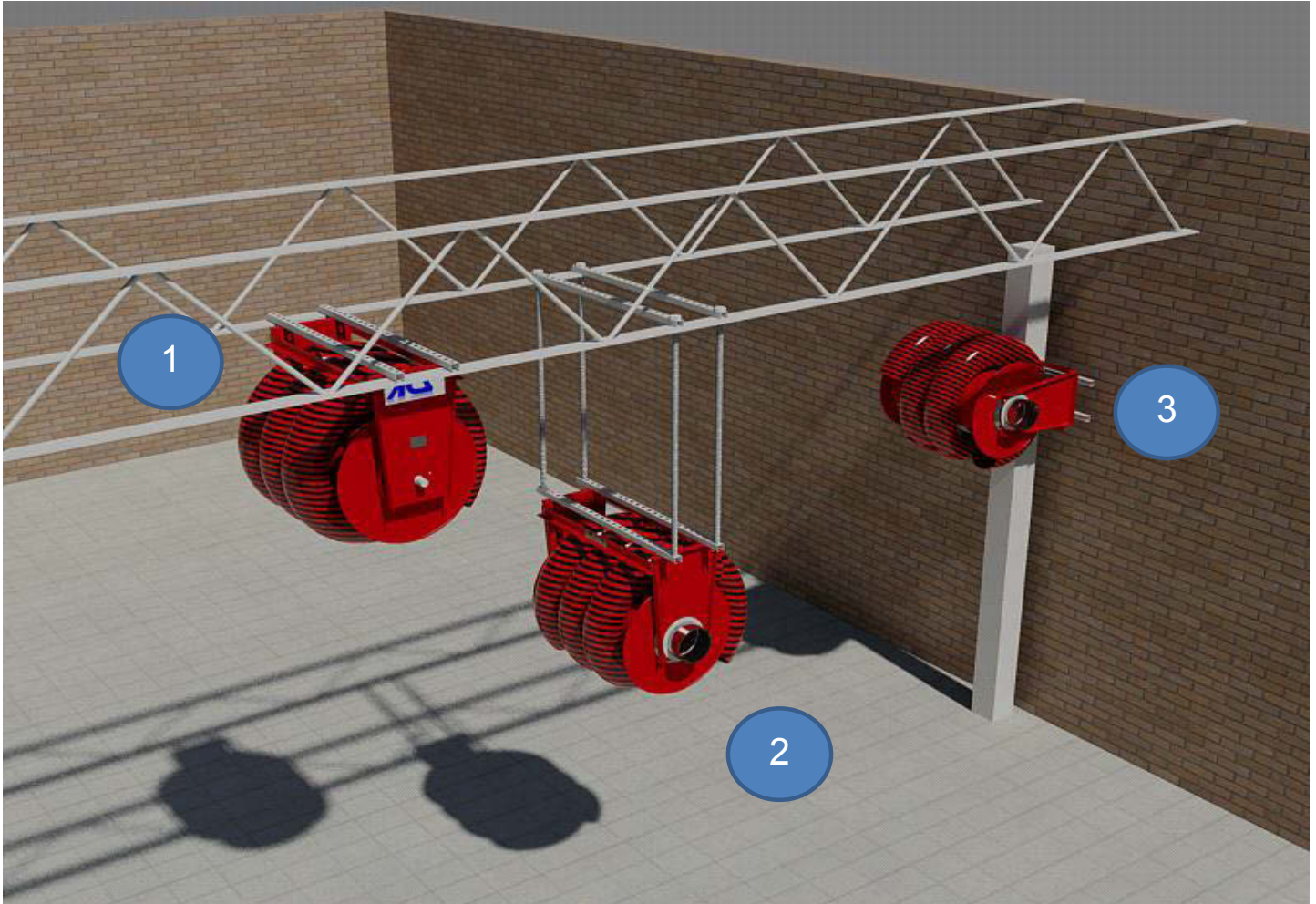

1. Ceiling mounting utilizing the Unistrut Steel Hangers.
2. Dropped down ceiling mount with Unistrut and 1/2" threaded rod for drop.
3. Wall mounted hose reel with Unistrut supports.

Installation Guides available upon request for most ceiling types including joist and concrete.

Hose Reels are a heavy item that has pull/push force from the spring retention. Please make sure the hose reel is mounted in a secure, strong location. Methods other than Unistrut and threaded rod are available.

Fume-A-Vent Type 2 600°F Nomex and Silicone Coated Hose

Date 7/12

Part No. H-02-XXXX

Type 2 600°F Hose

TAB 1-B

The Fume-A-Vent Type 2 hose easily withstands temperatures at 600°F and is ideal for use with hose reels or overhead exhaust systems. The hose has exceeded 1000°F during certified testing and is rated up to 1250°F with intermittent use.

Temperature Range: - 80°F to 600°F (Baking Test)

This product meets Military Spec: MIL PFR 62028 - Paragraph 4.7.8, 72 Hours at 1000°F.

This product has a temperature rating at 1250°F for intermittent use, 600° constant use.

The Fume-A-Vent Type 2 hose is a double ply hose with an inner liner ply of woven fiberglass coated silicone rubber. A helically wound spring steel wire is imbedded between the inner liner ply and an exterior ply of woven Nomex coated with silicone rubber. The wire insures maximum flexibility and minimum diameter restrictions in sharp bend areas. The assembly is double wound with a treated Nomex cord and heat vulcanized to provide a greater strength.

Other information including wall thickness and helix pitch are available upon request. In some cases, a Fan and a Tailpipe Adaptor will be required. Common lengths and diamaters shown in chart below.



Part No	Description	Wt
H-02-0416	Fume-A-Vent 4" x 16' Type 2 600°F Silicone/Nomex High Temperature Hose	15
H-02-0420	Fume-A-Vent 4" x 20' Type 2 600°F Silicone/Nomex High Temperature Hose	15
H-02-0424	Fume-A-Vent 4" x 24' Type 2 600°F Silicone/Nomex High Temperature Hose	18
H-02-0516	Fume-A-Vent 5" x 16' Type 2 600°F Silicone/Nomex High Temperature Hose	15
H-02-0520	Fume-A-Vent 5" x 20' Type 2 600°F Silicone/Nomex High Temperature Hose	16
H-02-0524	Fume-A-Vent 5" x 24' Type 2 600°F Silicone/Nomex High Temperature Hose	22
H-02-0616	Fume-A-Vent 6" x 16' Type 2 600°F Silicone/Nomex High Temperature Hose	15
H-02-0620	Fume-A-Vent 6" x 20' Type 2 600°F Silicone/Nomex High Temperature Hose	16
H-02-0624	Fume-A-Vent 6" x 24' Type 2 600°F Silicone/Nomex High Temperature Hose	18
H-02-0816	Fume-A-Vent 8" x 16' Type 2 600°F Silicone/Nomex High Temperature Hose	20
H-02-0820	Fume-A-Vent 8" x 20' Type 2 600°F Silicone/Nomex High Temperature Hose	24
H-02-0824	Fume-A-Vent 8" x 24' Type 2 600°F Silicone/Nomex High Temperature Hose	29



Air Cleaning
Specialists Inc.
11088 Gravois Ind. Ct.
St. Louis MO 63128
636-349-4400
636-349-0556 Fax

REVISIONS

0	

SHEET NAME
DETAIL



DRAWING TITLE
HRS-2-0616

DRAWN: CODY BINGAMAN

CHECKED: JIM GRAYEM

PROJECT NAME
HOSE REEL

DATE	VIEW
7/12/12	ORTHO

SIZE	DWG NO.	REV.
A	1	0

SCALE: 1:1 WEIGHT: 1 SHEET 1 OF 1

TOP VIEW

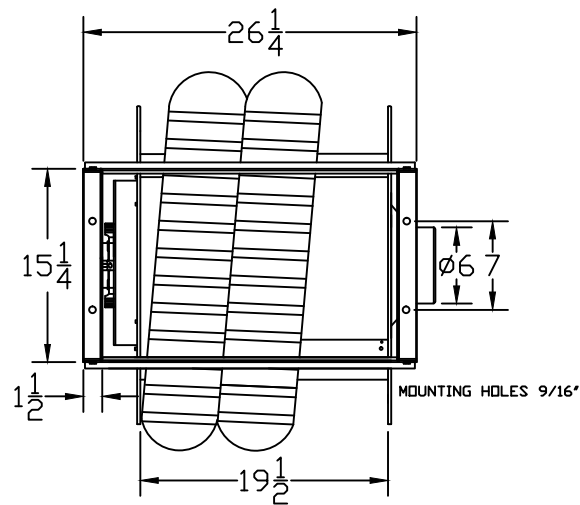

HOSE REEL
HRS-2-0616
6" 600° HOSE / 16' LENGTH

FRONT VIEW

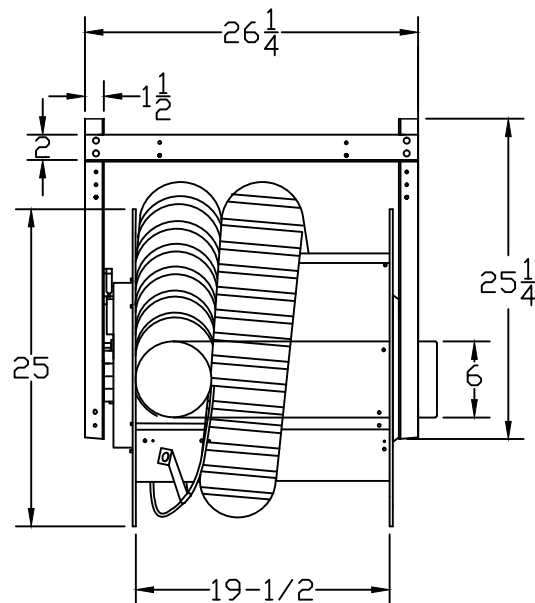

SIDE VIEW

